

# LEVEL TRANSMITTER

DATA SHEET

FKE...5

The FCX-AIII level transmitter accurately measures liquid level and transmits a proportional 4 to 20mA signal. The transmitter utilizes a unique micromachined capacitance silicon sensor with state-of-the-art microprocessor technology to provide exceptional performance and functionality.

## FEATURES

- High accuracy**  
0.2% accuracy for all calibrated spans is a standard feature for all models covering 0.32kPa {3.2mbar} range to 500kPa {5bar} high differential pressure range. 0.1% accuracy is available as option. Fuji's micro-capacitance silicon sensor assures this accuracy for all elevated or suppressed calibration ranges without additional adjustment.
- Minimum environmental influence**  
The "Advanced Floating Cell" design which protects the pressure sensor against changes in temperature, static pressure, and overpressure substantially reduces total measurement error in actual field applications.
- Fuji/HART® bilingual communications protocol**  
FCX-AIII series transmitter offers bilingual communications to speak both Fuji proprietary protocol and HART®. Any HART® compatible devices can communicate with FCX-AIII.
- Application flexibility**  
Various options that render the FCX-AIII suitable for almost any process applications include:
  - Full range of hazardous area approvals
  - Built-in RFI filter and lightning arrester
  - 5-digit LCD meter with engineering unit
  - Stainless steel electronics housing
  - Wide selection of materials
  - High temperature, high vacuum service.
- Programmable output Linearization Function**  
Output signal can be freely programmable. (Up to 14 compensated points at approximation.)
- Burnout current flexibility (Under Scale: 3.2 to 4.0mA, Over Scale: 20.0 to 22.5mA)**  
Burnout signal level is adjustable using Model FXW Hand Held Communicator (HHC) to comply with NAMUR NE43.
- Dry calibration without reference pressure**  
Thanks to the best combination of unique construction of mechanical parts (Sensor unit) and high performance electronics circuit (Electronics unit), reliability of dry calibration without reference pressure is at equal level as wet calibration.

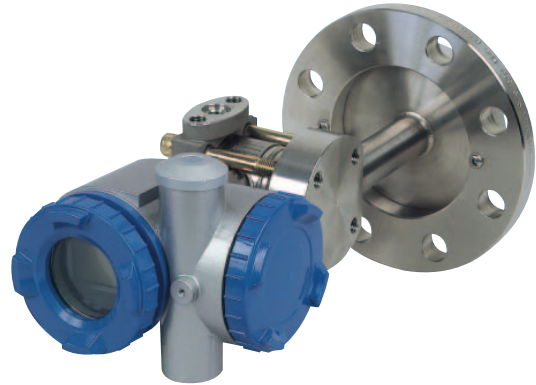

## SPECIFICATIONS

### Functional specifications

**Service:** Liquid, gas, or vapour  
**Static pressure, span, and range limit:**

Type	Static pressure	Span limit [kPa] (m bar)		Range limit [kPa] (m bar)
		Min.	Max.	
FKE□□3	} Up to flange rating	0.32	32	+/- 32
FKE□□5		{3.2}	{320}	{ +/- 320}
FKE□□6		{13}	{1300}	{ +/- 1300}
		5	500	+/- 500
		{50}	{5000}	{ +/- 5000}

Remark: To minimize environmental influence, span should be greater than 1/40 of the max. span in most applications.

- Lower limit of static pressure (vacuum limit) ;  
Silicone fill sensor: See Fig.1  
Fluorinated fill sensor: 66kPa abs (500mmHg abs) at temperature below 60 °C.
- The maximum span of each sensor can be converted to different units using factors as below.  
1MPa=10³kPa=10bar=10.19716kgf/cm²=145.0377psi  
1kPa=10mbar=101.9716mmH₂O=4.01463inH₂O

**Overrange limit:** To maximum static pressure limit  
**Output signal:** 4 to 20mA DC with digital signal superimposed on the 4 to 20mA signal  
**Power supply:** Transmitter operates on 10.5V to 45V DC at transmitter terminals.  
10.5V to 32V DC for the units with optional arrester.

Load limitations: see figure below

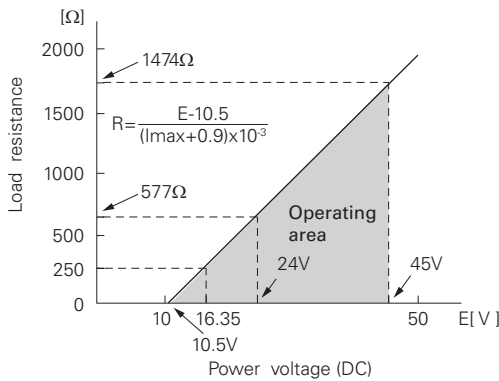

Note: For communication with HHC<sup>(1)</sup> (Model: FXW), min. of 250Ω required.

**Hazardous locations:** See TABLE 2

**Zero/span adjustment:**

Zero and span are adjustable from the HHC<sup>(1)</sup>. Zero and span are also adjustable externally from the adjustment screw.

**Damping:**

Adjustable from HHC or local configurator unit with LCD display. The time constant is adjustable between 0.06 to 32 seconds.

**Zero elevation/suppression:**

-100% to + 100% of URL

**Normal/reverse action:**

Selectable from HHC<sup>(1)</sup>

**Indication:**

Analog indicator or 5-digit LCD meter, as specified.

**Burnout direction:** Selectable from HHC<sup>(1)</sup>

If self-diagnostic detect transmitter failure, the analog signal will be driven to either "Output Hold", "Output Overscale" or "Output Underscale" modes.

"Output Hold": Output signal is hold as the value just before failure happens.

"Output Overscale": Adjustable within the range 20.0mA to 22.5mA from HHC<sup>(1)</sup>

"Output Underscale": Adjustable within the range 3.2mA to 4.0mA from HHC<sup>(1)</sup>

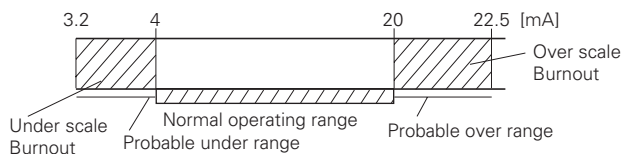

Output Limits conforming the NAMUR NE43 by order.

**Loop-check output:**

Transmitter can be configured to provide constant signal 3.2mA through 22.5mA by HHC<sup>(1)</sup>.

**Temperature limit:**

Ambient: -40 to + 85°C

(-20 to + 80°C for LCD indicator)

(-40 to + 60°C for arrester option)

(-10 to + 60°C for fluorinated oil fill transmitter)

For explosionproof units (flameproof or intrinsic safety), ambient temperature must be within the limits specified in each standard.

Process:

	Code in the 13th digit of "Code symbols"	Process temperature	Lower limit of static press
Fluorinated oil	W, A and D	-20 to 120°C	Atmospheric pressure
Silicone oil	H	-15 to 250°C	
	J	20 to 300°C	
	Y and G	-40 to 120°C	2.7kPa abs (20.3mmHg abs)
	S	-15 to 250°C	
	T	20 to 300°C	
	K	-15 to 150°C	0.13kPa abs (0.98mmHg abs)

Low pressure side contact liquid temperature on transmitter of Code H, J, S, T is 120°C or lower. Low pressure side contact liquid temperature of Code K is 85°C or lower

Storage: -40 to + 90°C

**Humidity limit:** 0 to 100% RH

**Communication:** With HHC<sup>(1)</sup> (Model FXW, consult Data Sheet No. EDS8-47), following items can be remotely displayed or configured.

Note: HHC's version must be higher than 7.0 (or FXW □□□□1-□4), for FCX-AIII.

**Local configurator with LCD display (option):**

Local configurator with 3 push button and LCD display can support following items.

Items	By communication with FXW		By local configurator (with 3 push button)	
	Display	Set	Display	Set
Tag No.	✓	✓	✓	✓
Model No.	✓	✓	✓	✓
Serial No. & Software Version	✓	—	✓	—
Engineering unit	✓	✓	✓	✓
Range limit	✓	—	✓	—
Measuring range	✓	✓	✓	✓
Damping	✓	✓	✓	✓
Output mode	✓	—	✓	—
Burnout direction	✓	✓	✓	✓
Calibration	✓	✓	✓	✓
Output adjust	—	✓	—	✓
Data	✓	—	✓	—
Self diagnoses	✓	—	✓	—
Printer (In case of FXW with printer option)	✓	—	—	—
External switch lock	✓	✓	✓	✓
Transmitter display	✓	✓	✓	✓
Linearize	✓	✓	—	—
Rerange	✓	✓	✓	✓
Saturate current	✓	✓	✓	✓
Write protect	✓	✓	✓	✓
History				
- Calibration history	✓	✓	✓	✓
- Ambient temperature history	✓	—	✓	—

**Programmable output linearization function:**

Output signal can be characterized with "14 points linear approximation function" from HHC<sup>(1)</sup>.

**EMC Conformity:** EN61326-1: 2006 CE

(Note) (1) HHC: Hand Held Communicator

## Performance specifications

Reference conditions, silicone oil fill, 316SS isolating diaphragms, 4-20 mA analog output in linear mode.

**Accuracy rating:** (including linearity, hysteresis, and repeatability)

(Standard)

For spans greater than 1/10 of URL:  $\pm 0.2\%$  of span

For spans below 1/10 of URL:

$$\pm \left( 0.1 + 0.1 \frac{0.1 \times \text{URL}}{\text{Span}} \right) \% \text{ of span}$$

(Option) (Code: 21th digit H, K)

For span greater than 1/10 of URL: 0.1% of span

For span below 1/10 of URL:

$$\pm \left( 0.05 + 0.05 \frac{0.1 \times \text{URL}}{\text{Span}} \right) \% \text{ of span}$$

**Stability:**  $\pm 0.2\%$  of upper range limit (URL) for 10 years.

**Temperature effect:**

Effects per 28°C change between the limits of -40°C and +85°C

$$\text{(Standard) Zero shift: } \pm \left( 0.35 \frac{\text{URL}}{X} \right) \%$$

$$\text{Total effect: } \pm \left( 0.5 \frac{\text{URL}}{X} \right) \%$$

(Option) (Code: 21th digit J, K)

Zero shift:  $\pm 0.3\%$  ( $X > 1/4 \text{URL}$ )

$$\pm \left( 0.1 + 0.2 \frac{0.25 \times \text{URL}}{X} \right) \% (X < 1/4 \text{URL})$$

Total effect:  $\pm 0.4\%$  ( $X > 1/4 \text{URL}$ )

$$\pm \left( 0.2 + 0.2 \frac{0.25 \times \text{URL}}{X} \right) \% (X < 1/4 \text{URL})$$

**Static pressure effect:**

Zero shift:  $\pm 0.2\%$  of URL / 1MPa

Span shift: -0.2% of calibrated span / 1MPa

**Overrange effect:** Zero shift;  $\pm 0.1\%$  of URL for flange rating pressure

**Supply voltage effect:**

Less than 0.005% of calibrated span per 1V

**Update rate:** 60 msec

**Step response:** (without electrical damping)

Range code	Time constant (at 23°C)	Dead time
"3"	0.55 s	0.12 s
"5" and "6"	0.3 s	

**Mounting position effect:**

Zero shift, less than 0.3kPa {3m bar} for a 10° tilt in any plane. (No extension)  
No effect on span.

This error can be corrected by adjusting zero.

**Dielectric strength:**

500V AC, 50/60Hz 1 min., between circuit and earth.

**Insulation resistance:**

More than 100MΩ at 500V DC.

**Internal resistance for external field indicator:**

12Ω or less

## Physical specifications

**Electrical connections:**

G1/2, 1/2-14 NPT, Pg13.5, or M20 x 1.5 conduit, as specified.

**Process connections:**

LP side: 1/4-18 NPT or Rc1/4.

HP side: ANSI, DIN, or JIS raised face flange. See OUTLINE DIAGRAM for detailed dimensions.

Refer to "Code symbols"

**Process-wetted parts material:**

Material code (7th digit in "code symbols")	Process cover	LP side	Wetted sensor body	HP side
		Diaphragm		Diaphragm & flange face
V	316 stainless (*1)	316L stainless	316 stainless	316L stainless
J	316 stainless (*1)	316L stainless	316 stainless	316L stainless steel +Au coating
C	316 stainless (*1)	316L stainless	316 stainless	Hastelloy-C
D	316 stainless (*1)	316L stainless	316 stainless	Monel
E	316 stainless (*1)	316L stainless	316 stainless	Tantalum
H	316 stainless (*1)	Hastelloy-C	Hastelloy-C lining	Hastelloy-C
M	316 stainless (*1)	Monel	Monel lining	Monel
T	316 stainless (*1)	Tantalum	Tantalum lining	Tantalum
P	316 stainless (*1)	316L stainless	316 stainless	Tantalum
R	316 stainless (*1)	316L stainless	316 stainless	Zirconium

Note: (\*1) SCS14A per JIS G 5121 (equivalent CF8M per ASTM A351/A351M)

Remark: Sensor O-rings: Viton O-ring and teflon gasket selectable.

**Non-wetted parts material:**

Electronics housing: Low copper die-cast aluminum alloy finished with polyester coating (standard), or 316 stainless steel (ASTM CF8M), as specified.

Bolts and nuts: Cr-Mo alloy (standard) or 304 stainless steel

Fill fluid: Silicone oil (standard) or fluorinated oil

Mounting flange: 304 stainless steel or Carbon steel, as specified

**Environmental protection:**

IEC IP67 and NEMA 6 / 6P

**Flange mounting:** See drawings

**Mass {weight}:** Transmitter approximately 10.2 to 19.2kg without options.

Add; 0.5kg for mounting bracket  
4.5kg for stainless steel housing option

1.0kg per 50mm extension of diaphragm

**Optional features**

- Indicator:** A plug-in analog indicator (2.5% accuracy).  
An optional 5-digit LCD meter with engineering unit is also available.
- Local configurator with LCD display:** An optional 5 digits LCD meter with 3 push buttons can support items as using communication with FXW.
- Arrester:** A built-in arrester protects the electronics from lightning surges.  
Lightning surge immunity:  
4kV (1.2 × 50µs)
- Oxygen service:** Special cleaning procedures are followed throughout the process to maintain all process wetted parts oil-free.  
The fill fluid is fluorinated oil.
- Chlorine service:** Oil-free procedures as above. Includes fluorinated oil for fill.
- Degreasing:** Process-wetted parts are cleaned, but the fill fluid is standard silicone oil. Not for use on oxygen or chlorine measurement.
- Vacuum service:** Special silicone oil and filling procedure are applied. See Fig.1 and Fig.2
- Optional tag plate:** An extra stainless steel tag with customer tag data is wired to the transmitter.
- Coating of cell:** Cell's surface is finished with epoxy/polyurethane double coating.  
Specify if environment is extremely corrosive.

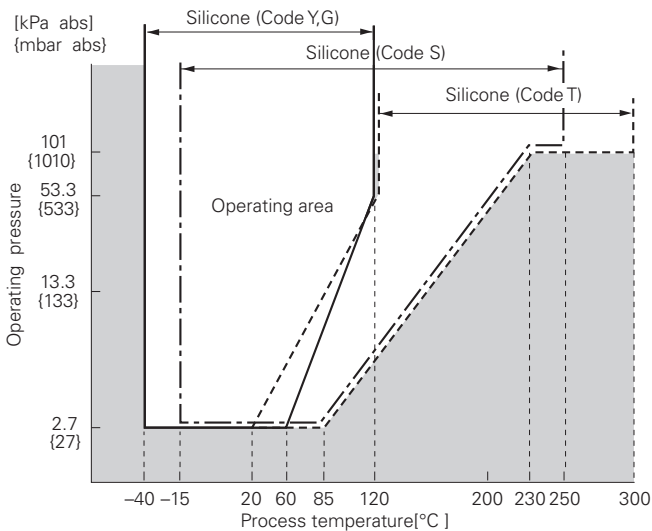

Fig. 1 Relation between process temperature and operating pressure

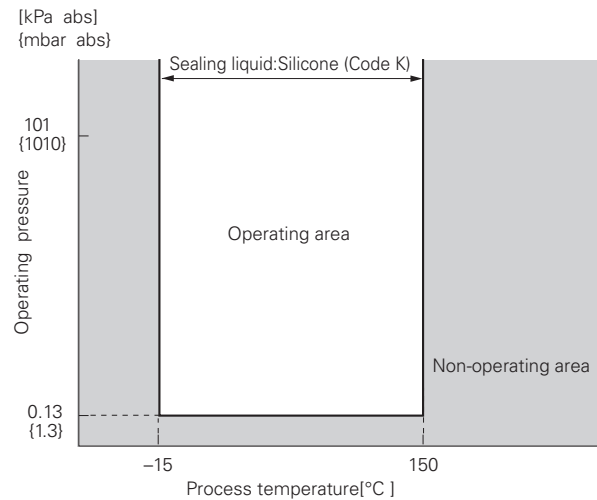

Fig. 2 Relation between process temperature and operating pressure

## ACCESSORIES

**Oval flanges:** (Model FFP, refer to Data Sheet No. EDS6-128)  
Converts process connection to 1/2-14 NPT or to Rc1/2; in carbon steel or in 316 stainless steel.

**Hand held communicator:**  
(Model FXW, refer to Data Sheet No. EDS 8-47)

## ORDERING INFORMATION

When ordering this instrument, specify:

1. CODE SYMBOLS
2. Measuring range
3. Output orientation (burnout direction) when abnormality is occurred in the transmitter.  
Hold / Overscale / Underscale.  
Unless otherwise specified, output hold function is supplied.
4. Indication method (indicated value and unit) in case of the actual scale (code D, H, P, S, 2, 5 on 9th digit).
5. TAG No. (up to 14 alphanumerical characters), if required.



Digit	Description	Note	1	2	3	4	5	6	7	8	9	10	11	12	13	14	15	21	Digit No. of code
9	<Indicator and arrester> Indicator None Analog, 0 to 100% linear scale Analog, custom scale None Analog, 0 to 100% linear scale Analog, custom scale Digital, 0 to 100% linear scale Digital, custom scale Digital, 0 to 100% linear scale Digital, custom scale Digital, 0 to 100% linear scale (Local configurator unit with LCD display) Digital, custom scale (Local configurator unit with LCD display) Digital, 0 to 100% linear scale (Local configurator unit with LCD display) Digital, custom scale (Local configurator unit with LCD display) Yes	Arrester None None None Yes Yes None None Yes Yes None None Yes None None None Yes Yes	F	K	E					5									
10	<Approvals for hazardous locations> None (for ordinary locations) TIIIS, Flameproof (Cable gland seal) (*8) TIIIS, Intrinsic safety FM, Flameproof (or explosionproof) (*11) FM, Intrinsic safety and nonincensive FM Combined of flameproof and intrinsic safety (*11) ATEX Flameproof (*10) ATEX Intrinsic safety ATEX Type n ATEX Combined of flameproof and intrinsic safety (*10) IECEX Scheme, Flameproof (*10) IECEX Scheme, Intrinsic safety CSA, Flameproof (or explosionproof) (*11) CSA, Intrinsic safety and nonincensive NEPSI, Flameproof (or explosionproof) NEPSI, Intrinsic safety NEPSI, Combined of flameproof and intrinsic safety	Note 8 Note 11 Note 11 Note 10 Note 10 Note 10 Note 10 Note 11									A C G D H V X K P M R T E J F S U								
11	<Diaphragm extension [mm]> Extension [mm]      Applicable material code 0                      Any 50 100 150 200 } (7th digit code "V" only)										Y A B C D								
12	<Options> Extra SS tag plate      Stainless steel elec. housing      Coating of cell None                      None                      None Yes                      None                      None None                      None                      Yes Yes                      None                      Yes None                      Yes                      Yes Yes                      Yes                      Yes } (*4)                      } (*7)	Note 4 Note 7 Note 7									Y B M N P Q								
13	<Special applications and fill fluid> Treatment              Fill fluid Standard              Silicone oil Standard              Fluorinated oil Degreasing              Silicone oil Oxygen service              Fluorinated oil (7th digit code "V", "J" only) Chlorine service              Fluorinated oil (7th digit code "H", "T", "B", "U", "C" and "E") High temp. 250°C } 7th digit code "V", "C", "H", "B" High temp. 300°C } High temp. and vacuum (250°C) High temp. and vacuum (300°C) High temp. and high vacuum Silicone oil } 7th digit code "V" } (* 5)	Note 5									Y W G A D H J S T K								
14	<O-ring, Gasket and Teflon membrane> Teflon (gasket) Teflon (gasket) and Teflon membrane 5th digit code "0", "2", "4", "6", "8", "A", "C", "E", "G", "J", "M", "R", "S", "T", "V", "X" and 11th digit code "Y" are available. 13th digit code "H", "J", "S", "T", "K" are not available. 7th digit code "V", "J" are available.																	B D	

Note 4: (\*4) Customer tag number can be engraved on standard stainless steel name plate. If extra tag plate is required, select "Yes"  
 Note 5: (\*5) Treatment; standard  
 Note 7: (\*7) Not available for 10th digit code "C".

Note 8: (\*8) Available for 4th digit code "S".  
 Note 10: (\*10) Available for 4th digit code "6", "8", "T", "W".  
 Note 11: (\*11) Available for 4th digit code "6", "T".

Digit	Description	Note	1	2	3	4	5	6	7	8	9	10	11	12	13	14	15	21	← Digit No. of code		
15	<Bolt/nut> (* 12) Cr-Mo alloy hexagon socket head cap screw/carbon steel nut Cr-Mo alloy hexagon bolt/carbon steel nut 304 stainless steel bolt /304 stainless steel nut 316 stainless steel bolt /316 stainless steel nut	Note 12	F	K	E					5											
21	<Other options> (* 6)	Note 6																			
	High accuracy type		Instruction manual attached																		H
	Low temperature effect type		Instruction manual attached																		J
	H+J		Instruction manual attached																		K
	Opposite Vent/Drain Plug Position		Instruction manual attached																		C
	Instruction manual unattached																				L
	High accuracy type		Instruction manual unattached																		T
	Low temperature effect type		Instruction manual unattached																		U
T+U	Instruction manual unattached																		V		
Opposite Vent/Drain Plug Position	Instruction manual unattached																		P		

Note 6: (\*6) If other option is not necessary, 21st digit code is blank.  
In case of 21st digit code is blank, instruction manual attached.

Note 12: (\*12) If case of tropical use, select stainless bolts and nuts.



# OUTLINE DIAGRAM (Unit:mm)

<AMP. case: L type>

5th digit of the code symbols	φD	φE	φF		φG	φH±1	t	P	N-φh	FLANGE
			Standard materials specification NOTE1)	Corrosion-resistant materials specification NOTE2)						
0, A, S	185	150	126	134	100	73	38	116	8-19	JIS-10K-80A
M	200	160	126	134	100	73	42	116	8-23	JIS-20K-80A
2, C	210	170	126	134	100	73	48	116	8-23	JIS-30K-80A
1, B	210	175	151	158	103	96	38	141	8-19	JIS-10K-100A
3, D	240	195	151	158	103	96	52	141	8-25	JIS-30K-100A
4, E, T	191	152.5	126	134	100	73	44	116	4-20	ANSI 150LB 3B
6, G, V	210	168	126	134	100	73	49	116	8-23	ANSI 300LB 3B
R, X	210	168	126	134	100	73	52	116	8-23	ANSI 600LB 3B
5, F, U	229	190.5	151	158	103	96	44	141	8-20	ANSI 150LB 4B
7, H, W	254	200	151	158	103	96	52	141	8-23	ANSI 300LB 4B
8, J	200	160	126	134	100	73	44	116	8-18	DIN PN40 DN80
9, K	220	180	151	158	103	96	40	141	8-18	DIN PN16 DN100

4th digit of the code symbols	conduit conn.			Press. Conn.	Oval flange screw
	D	E	F	H	
S	G1/2	18	2	Rc 1/4	7/16-20UNF SCREW DEPTH15
T	1/2-14NPT	16	4	1/4-18NPT	7/16-20UNF SCREW DEPTH15
V	Pg13.5	10.5	4.5	1/4-18NPT	M10 SCREW DEPTH15
W	M20×1.5	16	4	1/4-18NPT	M10 SCREW DEPTH15
X	Pg13.5	10.5	4.5	1/4-18NPT	7/16-20UNF SCREW DEPTH15

TABLE 1

NOTE1) In case of the 7th digit of type code is V, J.  
NOTE2) In case of the 7th digit of type code is C, D, E, H, M, T, P, R.

11th digit of the code symbols	L±1.5	MASS APPROX. (kg)	NOTE4)					
			L1	L2	L3	L4	L5	L6
Y	0	10.2 ~ 13.7	309	151	278	320	159	289
A, E	50	10.7 ~ 17.7	304	146	273	315	154	284
B, F	100	11.2 ~ 18.2						
C, G	150	11.7 ~ 18.7						
D, H	200	12.2 ~ 19.2						

IN CASE OF 4TH DIGIT CODE "S, V, W, X"

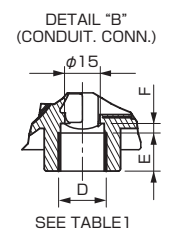
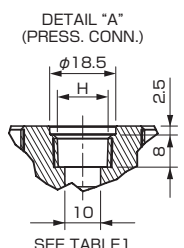
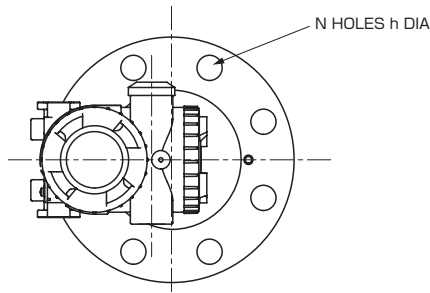
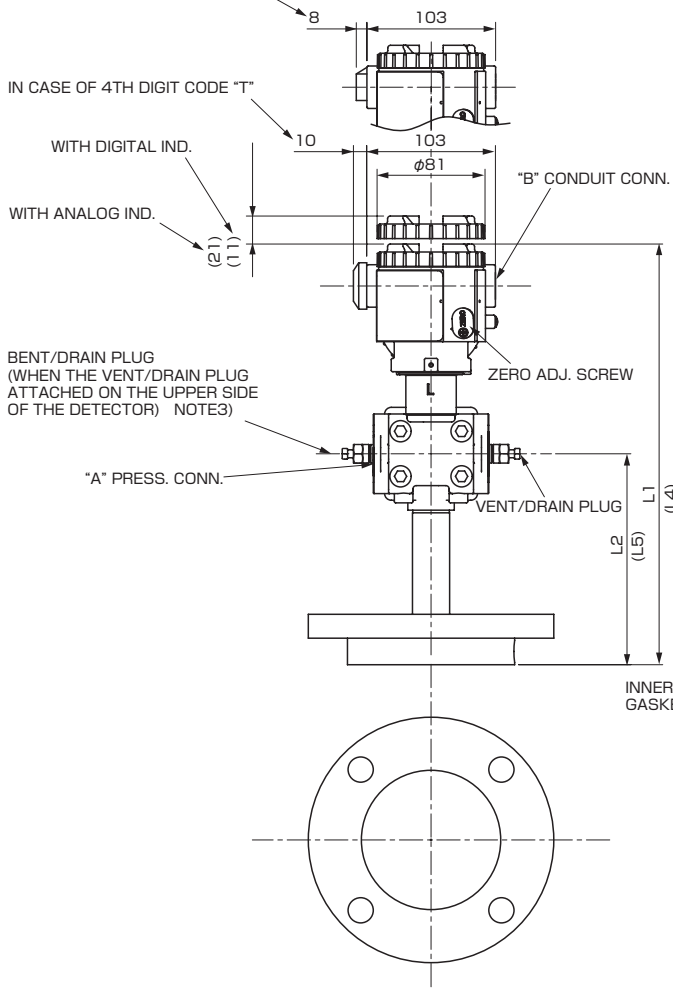

CONNECTION DIAGRAM

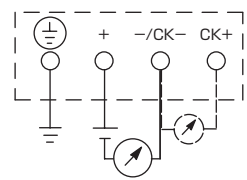

<SS TAG PLATE>

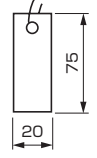

OPTION PARTS FOR FLAMEPROOF OF TIIS (JAPAN)

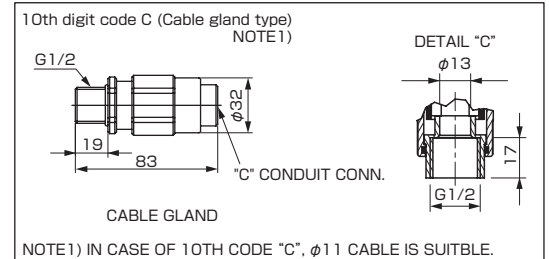

NOTE3) THE PRESSURE CONNECTOR IS LOCATED ON THE DOWN SIDE SURFACE OF THE DETECTOR, WHEN THE VENT/DRAIN PLUG IS ATTACHED ON THE UPPER SIDE OF THE DETECTOR (WHEN THE 21ST DIGIT OF THE CODE SYMBOLS : C.P).  
NOTE4) WHEN THE 7TH DIGIT OF THE CODE SYMBOLS : "H,M,T"

<AMP. case:T type>

5th digit of the code symbols	φD	φE	φF		φG	φH±1	t	P	N-φh	FLANGE
			Standard materials specification (NOTE1)	Corrosion-resistant materials specification (NOTE2)						
0, A, S	185	150	126	134	100	73	38	116	8-19	JIS-10K-80A
M	200	160	126	134	100	73	42	116	8-23	JIS-20K-80A
2, C	210	170	126	134	100	73	48	116	8-23	JIS-30K-80A
1, B	210	175	151	158	103	96	38	141	8-19	JIS-10K-100A
3, D	240	195	151	158	103	96	52	141	8-25	JIS-30K-100A
4, E, T	191	162.5	126	134	100	73	44	116	4-20	ANSI 150LB 3B
6, G, V	210	168	126	134	100	73	49	116	8-23	ANSI 300LB 3B
R, X	210	168	126	134	100	73	52	116	8-23	ANSI 600LB 3B
5, F, U	229	190.5	151	158	103	96	44	141	8-20	ANSI 150LB 4B
7, H, W	254	200	151	158	103	96	52	141	8-23	ANSI 300LB 4B
8, J	200	160	126	134	100	73	44	116	8-18	DIN PN40 DN80
9, K	220	180	151	134	103	96	40	141	8-18	DIN PN16 DN100

NOTE1) In case of the 7th digit of type code is V, J.  
NOTE2) In case of the 7th digit of type code is C, D, E, H, M, T, P, R.

4th digit of the code symbols	conduit conn.			Press. Conn.	Oval flange screw
	D	E	F	H	
5	G1/2	18	2	Rc 1/4	7/16-20UNF SCREW DEPTH15
6	1/2-14NPT	16	4	1/4-18NPT	7/16-20UNF SCREW DEPTH15
7	Pg13.5	10.5	4.5	1/4-18NPT	M10 SCREW DEPTH15
8	M20x1.5	16	4	1/4-18NPT	M10 SCREW DEPTH15
9	Pg13.5	10.5	4.5	1/4-18NPT	7/16-20UNF SCREW DEPTH15

TABLE 1

11th digit of the code symbols	L±1.5	MASS APPROX. (kg)	L1	L2	L3	NOTE4)		
						L4	L5	L6
Y	0	10.2 ~ 13.7	322	151	305	333	159	316
A, E	50	10.7 ~ 17.7	317	146	300	328	154	311
B, F	100	11.2 ~ 18.2						
C, G	150	11.7 ~ 18.7						
D, H	200	12.2 ~ 19.2						

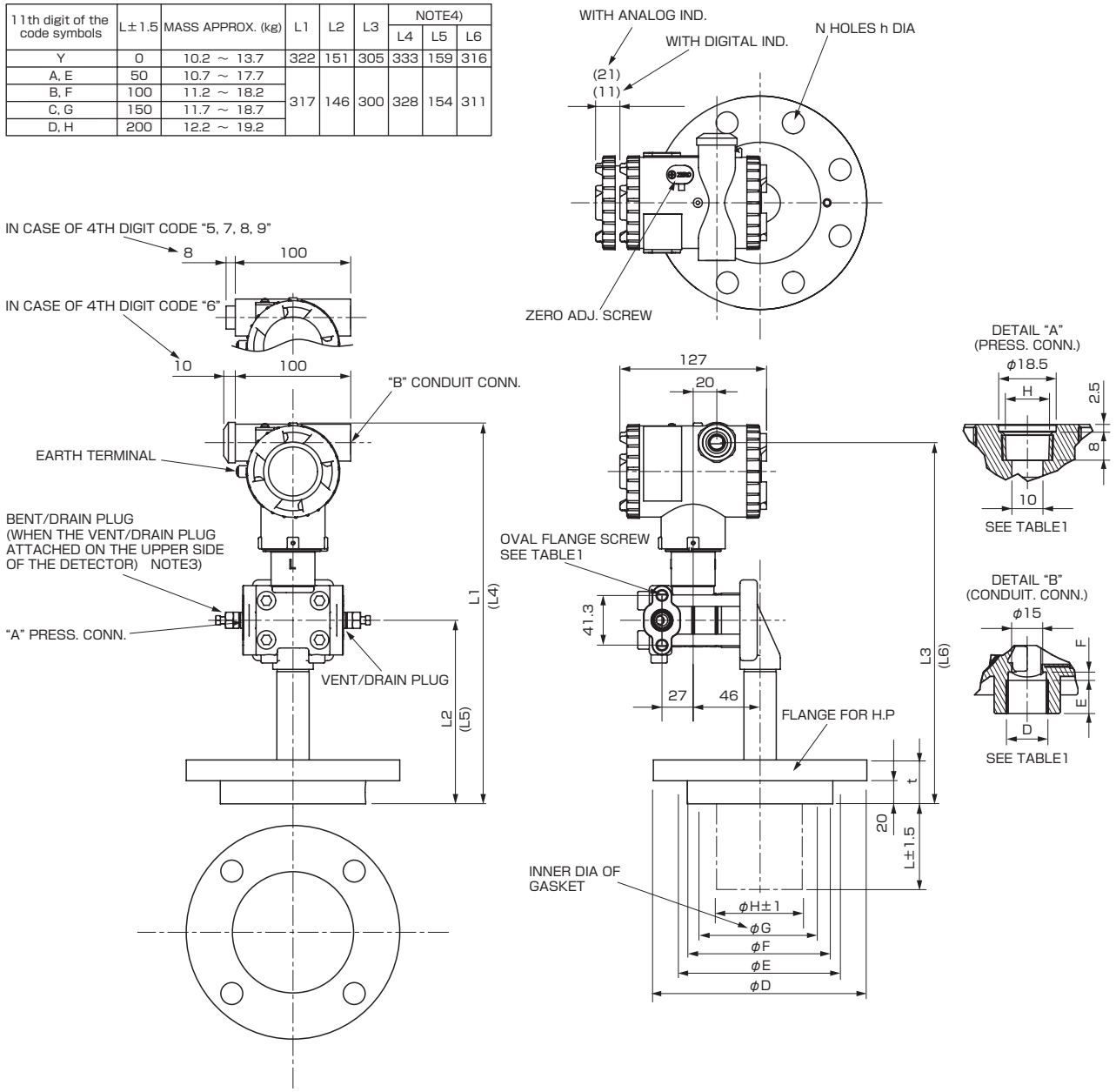

CONNECTION DIAGRAM

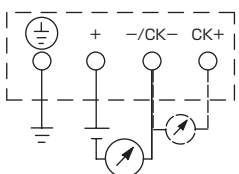

<SS TAG PLATE>

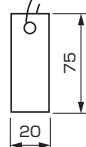

NOTE3) THE PRESSURE CONNECTOR IS LOCATED ON THE DOWN SIDE SURFACE OF THE DETECTOR, WHEN THE VENT/DRAIN PLUG IS ATTACHED ON THE UPPER SIDE OF THE DETECTOR (WHEN THE 21ST DIGIT OF THE CODE SYMBOLS : C,P).  
NOTE4) WHEN THE 7TH DIGIT OF THE CODE SYMBOLS "H,M,T"

TABLE 2

Authorities	Intrinsic safety																					
ATEX	<p>Ex II 1 G                      Ex ia IIC T5 Tamb = -40°C to +50°C                      Ex ia IIC T4 Tamb = -40°C to +70°C</p> <p>Entity Parameters:                      Ui=28V, Ii=94.3mA, Pi=0.66W,                      Ci=26nF (Without Arrester), Li=0.6mH (Without analog indicator),                      Ci=36nF (With Arrester), Li=0.7mH (With analog indicator)</p>																					
Factory Mutual	<p>Class I II III                      Div.1 Groups A, B, C, D, E, F, G                      T4 Entity Type 4X</p> <table border="1"> <thead> <tr> <th colspan="2">Model code</th> <th>Tamb</th> </tr> <tr> <th>9th digit</th> <th>13th digit</th> <th></th> </tr> </thead> <tbody> <tr> <td>A,B,D</td> <td>Y,G,H,J,S,T,K</td> <td>-40°C to +85°C</td> </tr> <tr> <td>L,P1,2</td> <td>Y,G,H,J,S,T,K</td> <td>-20°C to +80°C</td> </tr> <tr> <td>Q,S,4,5</td> <td>Y,G,H,J,S,T,K</td> <td>-20°C to +60°C</td> </tr> <tr> <td>E,F,H</td> <td>Y,G,H,J,S,T,K</td> <td>-40°C to +60°C</td> </tr> <tr> <td>-</td> <td>W,A,D</td> <td>-10°C to +60°C</td> </tr> </tbody> </table> <p>Entity Parameters:                      Vmax=28V, Imax=94.3mA, Pi=0.66W,                      Ci=35.98nF, Li=0.694mH</p>	Model code		Tamb	9th digit	13th digit		A,B,D	Y,G,H,J,S,T,K	-40°C to +85°C	L,P1,2	Y,G,H,J,S,T,K	-20°C to +80°C	Q,S,4,5	Y,G,H,J,S,T,K	-20°C to +60°C	E,F,H	Y,G,H,J,S,T,K	-40°C to +60°C	-	W,A,D	-10°C to +60°C
Model code		Tamb																				
9th digit	13th digit																					
A,B,D	Y,G,H,J,S,T,K	-40°C to +85°C																				
L,P1,2	Y,G,H,J,S,T,K	-20°C to +80°C																				
Q,S,4,5	Y,G,H,J,S,T,K	-20°C to +60°C																				
E,F,H	Y,G,H,J,S,T,K	-40°C to +60°C																				
-	W,A,D	-10°C to +60°C																				
CSA	<p>Class I                      Div.1 Groups A, B, C, D                      Class II                      Div.1 Groups E, F, G                      Class III                      Div.1</p> <p>Temp Code T5 Tamb max = +50°C                      Temp Code T4 Tamb max = +70°C</p> <p>Entity Parameters:                      Vmax=28V, Imax=94.3mA, Ci=25nF (Without Arrester),                      Ci=36nF (With Arrester), Li=0.6mH (Without analog meter),                      Li=0.7mH (With analog meter)</p>																					
TIIS	<p>Ex ia IIC T4                      Tamb max = +60°C</p> <p>Entity Parameters:                      Ui=28V, Ii=94.3mA, Pi=0.66W,                      Ci=38.4nF, Li=0.694mH</p>																					
IECEx Scheme	<p>Ex ia IIC T4                      Tamb = -40°C to +70°C                      Ex ia IIC T5                      Tamb = -40°C to +50°C</p> <p>Entity Parameters:                      Ui=28V, Ii=94.3mA, Pi=0.66W,                      Ci=26nF (Without Arrester), Li=0.6mH (Without analog indicator),                      Ci=36nF (With Arrester), Li=0.7mH (With analog indicator)</p>																					
NEPSI	<p>Ex ia IIC T4                      Ex d IIB+H<sub>2</sub> T6 / Ex ia IIC T4</p> <table border="1"> <thead> <tr> <th colspan="2">Model code</th> <th>Tamb</th> </tr> <tr> <th>9th digit</th> <th>13th digit</th> <th></th> </tr> </thead> <tbody> <tr> <td>A,B,D</td> <td>Y,G,H,J,S,T,K</td> <td>-40°C to +85°C</td> </tr> <tr> <td>L,P1,2</td> <td>Y,G,H,J,S,T,K</td> <td>-20°C to +80°C</td> </tr> <tr> <td>Q,S,4,5</td> <td>Y,G,H,J,S,T,K</td> <td>-20°C to +60°C</td> </tr> <tr> <td>E,F,H</td> <td>Y,G,H,J,S,T,K</td> <td>-40°C to +60°C</td> </tr> <tr> <td>-</td> <td>W,A,D</td> <td>-10°C to +60°C</td> </tr> </tbody> </table> <p>Entity Parameters:                      Ui=42.4V, Ii=113mA, Pi=1W,                      Ci=35.98nF, Li=0.694mH</p>	Model code		Tamb	9th digit	13th digit		A,B,D	Y,G,H,J,S,T,K	-40°C to +85°C	L,P1,2	Y,G,H,J,S,T,K	-20°C to +80°C	Q,S,4,5	Y,G,H,J,S,T,K	-20°C to +60°C	E,F,H	Y,G,H,J,S,T,K	-40°C to +60°C	-	W,A,D	-10°C to +60°C
Model code		Tamb																				
9th digit	13th digit																					
A,B,D	Y,G,H,J,S,T,K	-40°C to +85°C																				
L,P1,2	Y,G,H,J,S,T,K	-20°C to +80°C																				
Q,S,4,5	Y,G,H,J,S,T,K	-20°C to +60°C																				
E,F,H	Y,G,H,J,S,T,K	-40°C to +60°C																				
-	W,A,D	-10°C to +60°C																				

Authorities	Flameproof																					
ATEX	<p>Ex II 2 GD                      Ex d IIC T6 IP66/67 T85°C                      Tamb = -40°C to +65°C                      Ex d IIC T5 IP66/67 T100°C                      Tamb = -40°C to +85°C</p>																					
Factory Mutual	<p>Class I                      Div.1 Groups B, C, D                      T6 Type 4X                      Class II III                      Div.1 Groups E, F, G                      T6 Type 4X                      Tamb max = +60°C</p>																					
CSA	<p>Class I                      Div.1 Groups C, D                      Class II                      Div.1 Groups E, F, G                      Class III                      Div.1</p> <p>Note) "Seal Not Required" enclosure is allowed.</p>																					
TIIS	<p>Ex do IIB+H<sub>2</sub> T4                      Tamb max = +60°C                      Maximum process temp. = +120°C</p>																					
IECEx Scheme	<p>Ex d IIC T5 IP66/67                      Tamb = -40°C to +85°C                      Ex d IIC T6 IP66/67                      Tamb = -40°C to +65°C</p>																					
NEPSI	<p>Ex d IIB+H<sub>2</sub> T6                      Tamb = -40°C to +60°C</p>																					
Authorities	Type n Nonincendive																					
ATEX	<p>Ex II 3 GD                      EEx nL IIC T5 Tamb = -40°C to +50°C                      EEx nL IIC T4 Tamb = -40°C to +70°C</p> <p>Specific Parameters:                      Model without arrester:                      Ui=42.4V, Ii=113mA, Pi=1W,                      Ci=25.18nF, Li=0.694mH                      Model with arrester:                      Ui=32V, Ii=113mA, Pi=1W,                      Ci=35.98nF, Li=0.694mH</p> <p>EEx nAL IIC T5 Tamb = -40°C to +50°C                      EEx nAL IIC T4 Tamb = -40°C to +70°C</p> <p>Specific Parameters:                      Model without arrester:                      Umax=42.4V, Imax=113mA, Pmax=1W                      Model with arrester:                      Umax=32V, Imax=113mA, Pmax=1W</p>																					
Factory Mutual (pending)	<p>Class I II III                      Div.2 Groups A, B, C, D, F, G                      T4 Entity Type 4X</p> <table border="1"> <thead> <tr> <th colspan="2">Model code</th> <th>Tamb</th> </tr> <tr> <th>9th digit</th> <th>13th digit</th> <th></th> </tr> </thead> <tbody> <tr> <td>A,B,D</td> <td>Y,G,H,J,S,T,K</td> <td>-40°C to +85°C</td> </tr> <tr> <td>L,P1,2</td> <td>Y,G,H,J,S,T,K</td> <td>-20°C to +80°C</td> </tr> <tr> <td>Q,S,4,5</td> <td>Y,G,H,J,S,T,K</td> <td>-20°C to +60°C</td> </tr> <tr> <td>E,F,H</td> <td>Y,G,H,J,S,T,K</td> <td>-40°C to +60°C</td> </tr> <tr> <td>-</td> <td>W,A,D</td> <td>-10°C to +60°C</td> </tr> </tbody> </table>	Model code		Tamb	9th digit	13th digit		A,B,D	Y,G,H,J,S,T,K	-40°C to +85°C	L,P1,2	Y,G,H,J,S,T,K	-20°C to +80°C	Q,S,4,5	Y,G,H,J,S,T,K	-20°C to +60°C	E,F,H	Y,G,H,J,S,T,K	-40°C to +60°C	-	W,A,D	-10°C to +60°C
Model code		Tamb																				
9th digit	13th digit																					
A,B,D	Y,G,H,J,S,T,K	-40°C to +85°C																				
L,P1,2	Y,G,H,J,S,T,K	-20°C to +80°C																				
Q,S,4,5	Y,G,H,J,S,T,K	-20°C to +60°C																				
E,F,H	Y,G,H,J,S,T,K	-40°C to +60°C																				
-	W,A,D	-10°C to +60°C																				
CSA	<p>Class I                      Div.2 Groups A, B, C, D                      Class II                      Div.2 Groups E, F, G                      Class III                      Div.2</p> <p>Temp Code T5 Tamb max = +50°C                      Temp Code T4 Tamb max = +70°C</p> <p>Entity Parameters:                      Vmax=28V, Ci=25.18nF (Without Arrester),                      Ci=35.98nF (With Arrester), Li=0.694mH</p>																					

⚠ Caution on Safety

\*Before using this product, be sure to read its instruction manual in advance.

---

## Fuji Electric Co., Ltd.

**International Sales Div  
Sales Group**

Gate City Ohsaki, East Tower, 11-2, Osaki 1-chome,  
Shinagawa-ku, Tokyo 141-0032, Japan

<http://www.fujielectric.com>

Phone: 81-3-5435-7280, 7281 Fax: 81-3-5435-7425

<http://www.fjelectric.com/products/instruments/>